

YI Home Camera

1. Camera complectation

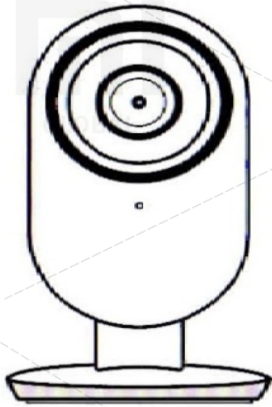

YI 1080P home camera 2 x 1



Instruction x 1

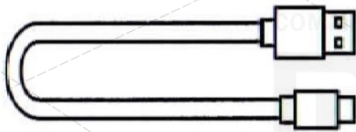

Micro USB cable x 1



Adapter x 1

2. Introduction to the camera

Camera settings: remove the back cover (see. Next section), press and hold the start button until yellow light.

Front View

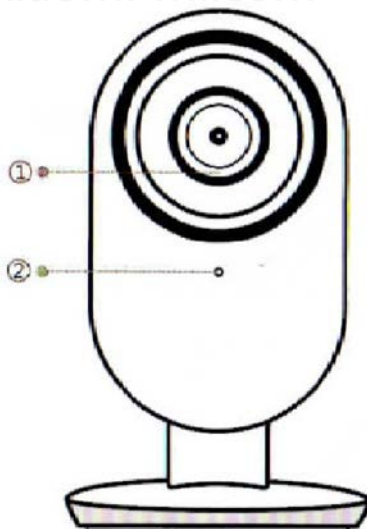

Description of the status of the indicator lights:

Yellow light
Power On

Flashing yellow
WiFi search

Flashing blue
WiFi connection

Blue light
Connection succeed

Slow flashing yellow
firmware updating

1. Light indicator 2. Microphone

3. Removing the back cover

Squeeze the left and right bottom grooves and slide the cover up.

Side view:

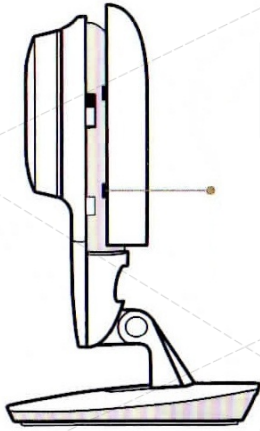

To remove the back cover, squeeze a left and right bottom grooves and slide the cover up.

4. Installing MicroSD card

Remove the back cover and insert a Micro-SD card to slot on the side, as shown below.

Back view:

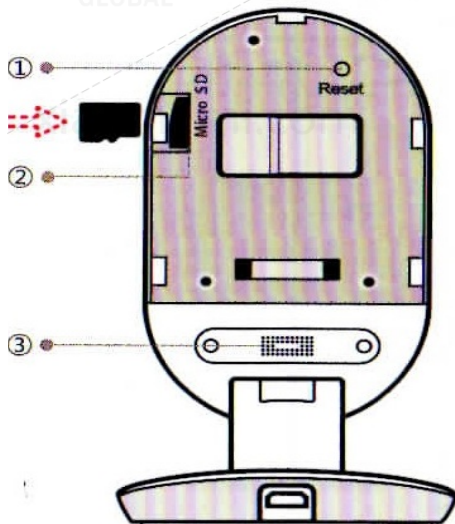

Detail Name / Description

Micro-SD Card Slot

To enable local video recording, insert a Micro-SD card to slot as shown in the picture.

* Support Class 4 or higher of Micro-SD card, format 8GB-64GB, file system FAT32.

Reset button

To launch the camera, press and hold the start button until the indicator lights yellow.

Dynamic

The speaker is used for 2-way audio. For best results, do not cover.

1. Reset button

2. Micro-SD card slot

3. Dynamic

5. Installing the App

Download the app by searching "YI Home» on the App Store or Google Play. As an alternative, you can open the app for scanning QR and scan Yi Home QR-code, shown below. to install the application.



YI Home App QR-code

6. Registration and login

1. Open YI Home App and select "North America" as a point of entry into the system.
2. Enter your login credentials. If you do not have a private page, you can create one by clicking "Register" and follow the instructions in the application to create an YI account. Also in order to log, you can use your Facebook page.

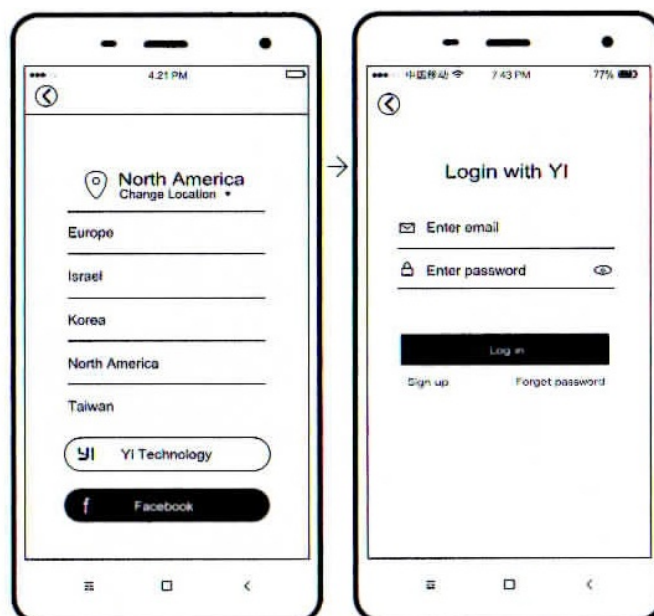

7. Turning on the camera's power

Install the camera close to a router and make sure that you have access to WiFi, then connect a cable to Micro-USB port on back of the camera to a power outlet as shown on the picture.

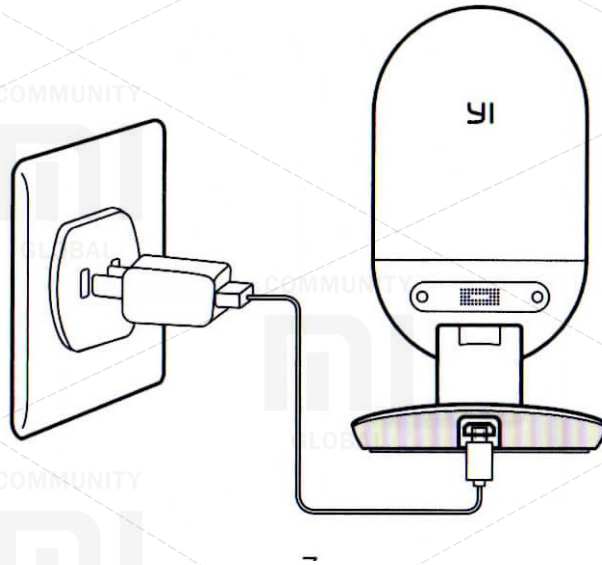

8. Connecting the camera to a phone

1. To connect the camera to home screen, touch adding badge "+" in the upper right corner.
2. Follow simple instructions to configure the application. You can set up multiple cameras one at a time.



9. Preview, live shooting

Use the YI Home app, to watch what happens live on your phone. You can also record and save video or images.

Note: in many countries, it's illegal to recording audio conversations without permission of all persons. When using YI Home camera follow all applicable laws.

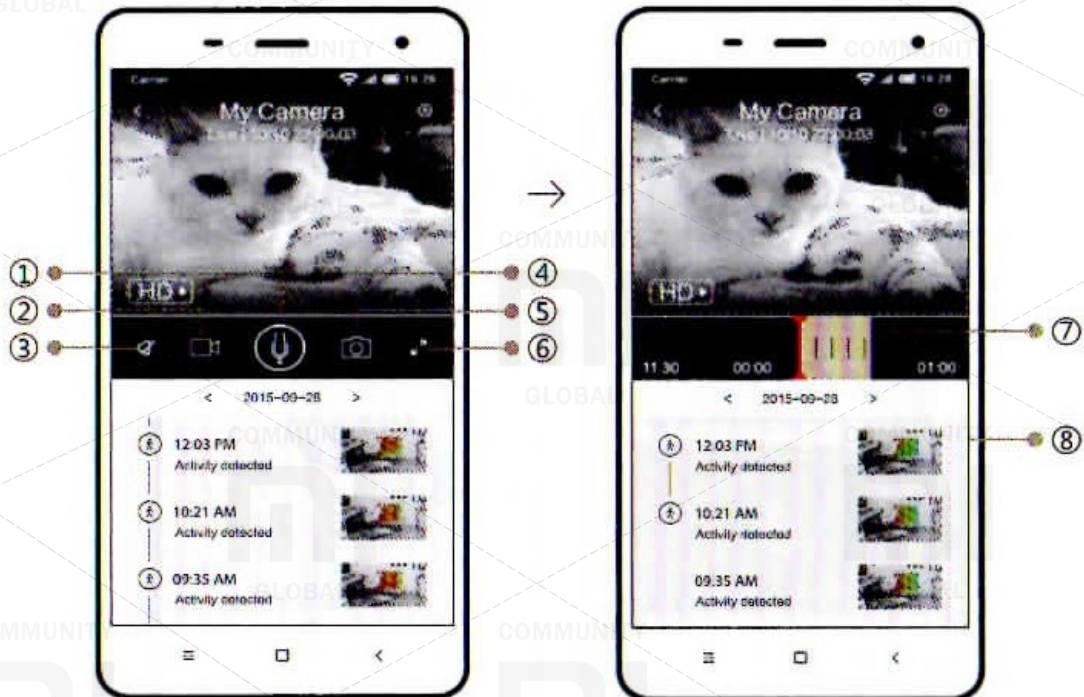

1. Hold to talk;
2. Video Recording;
3. Silent;
4. Show Timeline;
5. Take photos;
6. Full Screen;
7. Play history;
8. Warning.

10. Switching WiFi network

When you need to switch a WiFi network or update your WiFi password, follow the instructions below:

1. Use a clamp to press the start button on a back of the camera, and wait until the LED turns yellow.
2. Open YI Home App on your phone, and then go to step 6 - Connecting the camera to a phone. Your videos that stored on Micro-SD will not be damaged.

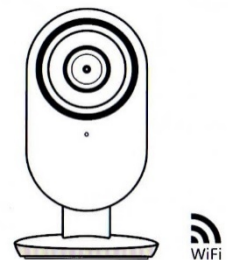

Recommendations

1. Set the camera to an open place for WiFi signal and away from metal objects.
2. Avoid placing the camera behind furniture, near the microwave and in places with cables twisted together.

This product is designed, manufactured and assembled in China. Sales and intended operating environment of this product is limited to the United States. So it's do not guaranteed that this part or all of the services and functionality available when using this product outside the United States.



FAQ

Important safety instructions

1. Read these instructions.
2. Clean only with dry cloth.
3. This camera is designed for indoor use only.
4. Use only device / accessories specified by the manufacturer.
5. Do not forget to switch off the device during lightning storms or when it's not used for a long period of time.
6. To achieve the best use of this product, please consistently update to the latest version our application and firmware.

WARNING:

Open flame sources such as candles should not be placed near or on the product.

Note:

"Xiaomi" and "YI" logo are trademarks of Shanghai Xiaoyi Technology Co., Ltd.

This device complies with Part 15 of the Rules of FCC (Federal Communications Agency) / Industry Canada released from a licensed standard (s) RSS. The operation is possible if the following two conditions: (1) This device may not cause harmful interference, and (2) this device must accept any interference received, including interference that may cause undesired operation.

Congratulations!

Your YI 1080P Home Camera is ready for use.

Changes or modifications not approved by the party responsible for compliance could void the user's authority to operate the equipment.

This equipment has been checked for compliance with limits for Class B digital device, pursuant to Part 15 of the Rules FCC. These limits are designed to provide moderate protection against harmful interference in residential areas. This equipment generates, uses, and can radiate radio frequency energy and, if installed and used in accordance with the instructions, may cause interference to radio communications. However, there is no guarantee that interference will not occur at a particular installation. In case of improper installation causes interference to radio or television reception, which can be determined by the inclusion and exclusion of equipment, the user can try to correct the interference by one or more of the following measures:

- Reorient or relocate the receiving antenna.
- Increase the separation between the equipment and receiver.
- Connect the equipment into an outlet different from that to which the receiver is connected.
- Contact your service provider or a qualified radio / TV.